

Internal-Switch Boost Regulator with Integrated High-Voltage Level Shifter and Op Amp

General Description

The MAX17010 contains a high-performance step-up switching regulator, a high-speed operational amplifier (op amp), and a high-voltage level-shifting scan driver. The device is optimized for thin-film transistor (TFT) liquid-crystal display (LCD) applications.

The step-up DC-DC converter provides the regulated supply voltage for the panel-source driver ICs. The converter is a 1.2MHz current-mode regulator with an integrated 20V n-channel power MOSFET. The high switching frequency allows the use of ultra-small inductors and ceramic capacitors. The current-mode control architecture provides fast transient response to pulsed loads. The step-up regulator features undervoltage lockout (UVLO), soft-start, and internal current limit. The high-current op amp is designed to drive the LCD backplane (VCOM). The amplifier features high output current ($\pm 150\text{mA}$), fast slew rate ($45\text{V}/\mu\text{s}$), wide bandwidth (20MHz), and rail-to-rail inputs and outputs.

The high-voltage, level-shifting scan driver is designed to work with panels that incorporate row drivers on the panel glass. Its eight outputs swing from +30V (max) to -10V and can swiftly drive capacitive loads.

The MAX17010 is available in a 40-pin thin QFN package with a maximum thickness of 0.8mm for ultra-thin LCD panels. The device operates over the -40°C to $+85^\circ\text{C}$ temperature range.

Applications

Notebook Computer Displays
LCD Monitor Panels

Ordering Information

PART	TEMP RANGE	PIN-PACKAGE
MAX17010ETL+	-40°C to $+85^\circ\text{C}$	40 Thin QFN-EP* (5mm x 5mm)

+Denotes a lead-free package.

*EP = Exposed paddle.

Pin Configuration appears at end of data sheet.

Features

- ◆ 1.8 V to 5.5V IN Supply Voltage Range
- ◆ 3mA SUP Quiescent Current (Switching)
- ◆ 1.2MHz Current-Mode Step-Up Regulator
 - Fast Transient Response
 - High-Accuracy Output Voltage (1.0%)
 - Built-In 20V, 1.9A, 200m Ω MOSFET
 - High Efficiency (> 85%)
 - Digital Soft-Start
- ◆ High-Speed Op Amp
 - 150mA Output Current
 - 45V/ μs Slew Rate
 - 20MHz, -3dB Bandwidth
- ◆ High-Voltage Level-Shifting Scan Drivers
 - Logic-Level Inputs
 - +30V to -10V Output Rails
- ◆ Thermal-Overload Protection
- ◆ 40-Pin, 5mm x 5mm, Thin QFN Package

Minimal Operating Circuit

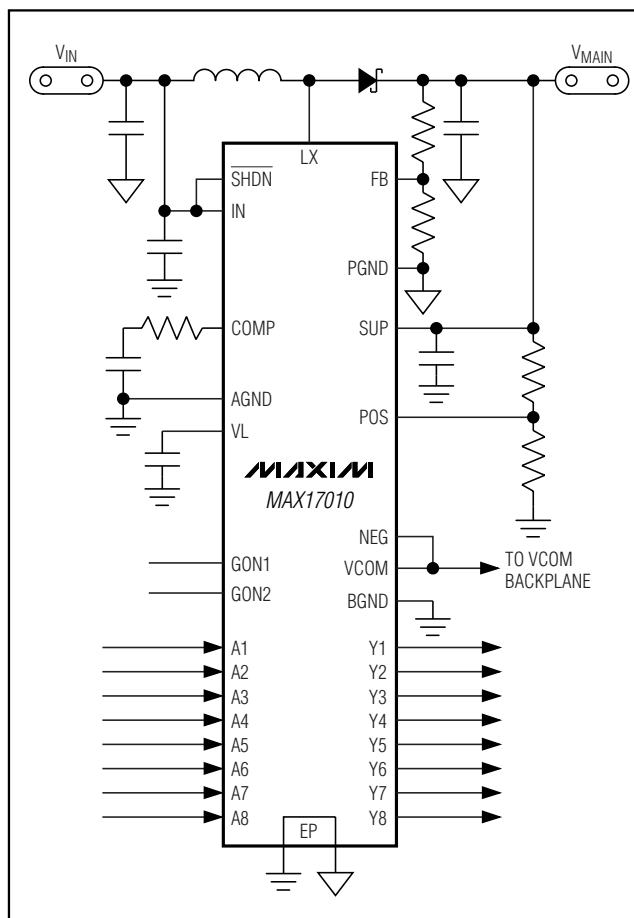

Internal-Switch Boost Regulator with Integrated High-Voltage Level Shifter and Op Amp

ABSOLUTE MAXIMUM RATINGS

IN, $\overline{\text{SHDN}}$ to GND	-0.3V to +7.5V	Y1–Y6 to AGND	(V _{G_{OFF}} - 0.3V) to (V _{G_{ON1}} + 0.3V)
VL to AGND	-0.3V to +6.0V	Y7, Y8 to AGND	(V _{G_{OFF}} - 0.3V) to (V _{G_{ON2}} + 0.3V)
COMP, FB to GND	-0.3V to (VL + 0.3V)	LX, PGND RMS Current Rating	2.4A
VCOM, NEG, POS to BGND	-0.3V to (V _{SUP} + 0.3V)	Continuous Power Dissipation (T _A = +70°C) NiPd Lead Frame with Nonconductive Epoxy	
LX to GND	-0.3V to +20V	40-Pin, 5mm x 5mm, Thin QFN (derate 35.7mW/°C above +70°C)	2857mW
SUP to GND	-0.3V to +20V	Operating Temperature Range	-40°C to +85°C
A ₋ to AGND	-0.3V to +20V	Junction Temperature	+150°C
A ₋ Input Current	20mA	Storage Temperature Range	-65°C to +150°C
PGND, BGND to AGND	-0.3V to +0.3V	Lead Temperature (soldering, 10s)	+300°C
GON1, GON2 to AGND	-0.3V to +32V		
G _{OFF} to AGND	-12V to +0.3V		

Stresses beyond those listed under "Absolute Maximum Ratings" may cause permanent damage to the device. These are stress ratings only, and functional operation of the device at these or any other conditions beyond those indicated in the operational sections of the specifications is not implied. Exposure to absolute maximum rating conditions for extended periods may affect device reliability.

ELECTRICAL CHARACTERISTICS

(V_{IN} = V_{SHDN} = +3V, Circuit of Figure 1, SUP = 8.5V, V_{GON1} = V_{GON2} = 30V, V_{G_{OFF}} = -10V, V_{POS} = V_{NEG} = 4V, T_A = 0°C to +85°C. Typical values are at T_A = +25°C, unless otherwise noted.)

PARAMETER	CONDITIONS	MIN	TYP	MAX	UNITS
IN Input-Voltage Range		1.8		5.5	V
IN Quiescent Current	V _{IN} = 3V, V _{FB} = 1.5V, not switching		0.05	0.10	mA
IN Undervoltage Lockout	IN rising; typical hysteresis 100mV; LX remains off below this level		1.30	1.75	V
Thermal Shutdown	Rising edge, 15°C hysteresis		160		°C
BOOTSTRAP LINEAR REGULATOR (VL)					
VL Output Voltage		3.8	4.0	4.2	V
VL Undervoltage Lockout	VL rising, 200mV hysteresis (typ)	2.4	2.7	3.0	V
VL Maximum Output Current	V _{FB} = 1V	10			mA
MAIN DC-DC CONVERTER					
SUP Supply Current	V _{FB} = 1.5V, no load		1.5	2.5	mA
	V _{FB} = 1.1V, no load		3.5	4.5	
Operating Frequency		990	1170	1350	kHz
Oscillator Maximum Duty Cycle		88	92	96	%
FB Regulation Voltage	FB = COMP	1.222	1.235	1.248	V
FB Load Regulation	0 < I _{MAIN} < 200mA, transient only		-1		%
FB Line Regulation	V _{IN} = 1.8V to 5.5V		0		%/V
FB Input Bias Current	V _{FB} = 1.3V	50	125	200	nA
FB Transconductance	ΔI = 5μA at COMP	75	160	280	μS
FB Voltage Gain	FB to COMP		2400		V/V
FB Fault-Timer Trip Threshold	Falling edge	0.96	1.00	1.04	V
FB Undervoltage Switching Inhibit		50	100	150	mV
LX On-Resistance	I _{LX} = 200mA		200	330	mΩ
LX Leakage Current	V _{LX} = 13V		0.01	20	μA
LX Current Limit	65% duty cycle	1.6	1.9	2.2	A
Current-Sense Transresistance		0.25	0.42	0.55	V/A
Soft-Start Period			3		ms

Internal-Switch Boost Regulator with Integrated High-Voltage Level Shifter and Op Amp

ELECTRICAL CHARACTERISTICS (continued)

($V_{IN} = V_{\overline{SHDN}} = +3V$, Circuit of Figure 1, $SUP = 8.5V$, $V_{GON1} = V_{GON2} = 30V$, $V_{GOFF} = -10V$, $V_{POS} = V_{NEG} = 4V$, $T_A = 0^\circ C$ to $+85^\circ C$. Typical values are at $T_A = +25^\circ C$, unless otherwise noted.)

PARAMETER	CONDITIONS	MIN	TYP	MAX	UNITS
CONTROL INPUTS					
SHDN Input-Low Voltage				0.6	V
SHDN Input-High Voltage	$1.8V \leq V_{IN} \leq 3.0V$	1.8			V
	$3.0V \leq V_{IN} \leq 5.5V$	2.0			
Maximum \overline{SHDN} Input Current		-1		+1	μA
OP AMP					
SUP Supply Range		5		18	V
SUP Overvoltage Threshold	(Note 1)	18.1	19.0	19.9	V
SUP Undervoltage Threshold	(Note 2)			1.4	V
Input Offset Voltage	$V_{NEG}, V_{POS} = V_{SUP} / 2$			12	mV
Input Bias Current	$V_{NEG}, V_{POS} = V_{SUP} / 2$	-50		+50	nA
Input Common-Mode Voltage Range		0		V_{SUP}	V
VCOM Output-Voltage Swing High	$I_{VCOM} = 5mA$	$V_{SUP} - 100$	$V_{SUP} - 50$		mV
VCOM Output-Voltage Swing Low	$I_{VCOM} = -5mA$		50	100	mV
VCOM Output Current High	$V_{VCOM} = V_{SUP} - 1V$		+75		mA
VCOM Output Current Low	$V_{VCOM} = 1V$		-75		mA
Slew Rate			40		V/ μs
-3dB Bandwidth			20		MHz
VCOM Short-Circuit Current	Short to $V_{SUP} / 2$, sourcing	50	150		mA
	Short to $V_{SUP} / 2$, sinking	50	150		
HIGH-VOLTAGE SCAN DRIVER					
GON1 Input-Voltage Range		12		30	V
GON2 Input-Voltage Range		12		30	V
GOFF Input-Voltage Range		-10		-5	V
GOFF Supply Current	A1–A8 = AGND, no load		75	125	μA
GON1 Supply Current	A1–A8 = AGND, no load		30	60	μA
GON2 Supply Current	A1–A8 = AGND, no load		10	20	μA
Output-Voltage Low (Y1–Y8)	$I_{OUT} = 10mA$		$V_{GOFF} + 0.3$	$V_{GOFF} + 1.0$	V
Output-Voltage High (Y1–Y6)	$I_{OUT} = 10mA$	$V_{GON1} - 1.0$	$V_{GON1} - 0.3$		V
Output-Voltage High (Y7–Y8)	$I_{OUT} = 10mA$	$V_{GON2} - 1.0$	$V_{GON2} - 0.3$		V
Propagation Delay	$C_{LOAD} = 100pF$ (Note 3)		40	80	ns
Rise Time (Y1–Y8)	$C_{LOAD} = 100pF$ (Note 3)		16	35	ns
Fall Time (Y1–Y8)	$C_{LOAD} = 100pF$ (Note 3)		16	35	ns
Maximum Operating Frequency	$C_{LOAD} = 100pF$ (Note 3)	50			kHz

Internal-Switch Boost Regulator with Integrated High-Voltage Level Shifter and Op Amp

ELECTRICAL CHARACTERISTICS (continued)

($V_{IN} = V_{SHDN} = +3V$, Circuit of Figure 1, $SUP = 8.5V$, $V_{GON1} = V_{GON2} = 30V$, $V_{GOFF} = -10V$, $V_{POS} = V_{NEG} = 4V$, $T_A = 0^\circ C$ to $+85^\circ C$. Typical values are at $T_A = +25^\circ C$, unless otherwise noted.)

PARAMETER	CONDITIONS	MIN	TYP	MAX	UNITS
CONTROL INPUTS					
Logic Input-Voltage Threshold Rising (A1–A8)		1.2	1.6	2.0	V
Logic Input-Voltage Threshold Falling (A1–A8)		0.7	0.9	1.12	V
Logic Input-Voltage Hysteresis			0.7		V
Logic Input Bias Current (A1–A8)	$V_{A1-A8} = 18V$		20	45	μA

ELECTRICAL CHARACTERISTICS

($V_{IN} = V_{SHDN} = +3V$, Circuit of Figure 1, $SUP = 8V$, $V_{GON1} = V_{GON2} = 30$, $V_{GOFF} = -10V$, $V_{POS} = V_{NEG} = 4V$, $OE = 0V$, $T_A = -40^\circ C$ to $+85^\circ C$.) (Note 4)

PARAMETER	CONDITIONS	MIN	TYP	MAX	UNITS
IN Input-Voltage Range		1.8		5.5	V
IN Quiescent Current	$V_{IN} = 3V$, $V_{FB} = 1.5V$, not switching			0.1	mA
IN Undervoltage Lockout	IN rising; 100mV hysteresis (typ); LX remains off below this level			1.75	V
BOOTSTRAP LINEAR REGULATOR (VL)					
VL Output Voltage		3.8		4.2	V
VL Undervoltage Lockout	VL rising, 200mV hysteresis (typ)	2.4		3.0	V
VL Maximum Output Current	$V_{FB} = 1V$	10			mA
MAIN DC-DC CONVERTER					
SUP Supply Current	$V_{FB} = 1.5V$, no load			2.8	mA
	$V_{FB} = 1.1V$, no load			5.0	
Operating Frequency		990		1350	kHz
Oscillator Maximum Duty Cycle		88		96	%
FB Regulation Voltage	FB = COMP	1.216		1.254	V
FB Transconductance	$\Delta I = 5\mu A$ at COMP	75		280	μS
FB Fault Timer Trip Threshold	Falling edge	0.96		1.04	V
FB Undervoltage Switching Inhibit		50		150	mV
LX On-Resistance	$I_{LX} = 200mA$			330	$m\Omega$
LX Current Limit	65% duty cycle	1.6		2.2	A
OP AMP					
SUP Supply Range		5		18	V
SUP Overvoltage Fault Threshold	(Note 1)	18		19.9	V
SUP Undervoltage Fault Threshold	(Note 2)			1.4	V
Input Offset Voltage	$V_{NEG}, V_{POS} = V_{SUP} / 2$			12	mV
Input Common-Mode Voltage Range		0		V_{SUP}	V
VCOM Output-Voltage Swing High	$I_{VCOM} = 5mA$	$V_{SUP} - 100$			mV
VCOM Output-Voltage Swing Low	$I_{VCOM} = -5mA$			100	mV
VCOM Short-Circuit Current	Short to $V_{SUP} / 2$, sourcing	50			mA
	Short to $V_{SUP} / 2$, sinking	50			

Internal-Switch Boost Regulator with Integrated High-Voltage Level Shifter and Op Amp

ELECTRICAL CHARACTERISTICS (continued)

($V_{IN} = V_{SHDN} = +3V$, Circuit of Figure 1, $SUP = 8V$, $V_{GON1} = V_{GON2} = 30$, $V_{GOFF} = -10V$, $V_{POS} = V_{NEG} = 4V$, $OE = 0V$, $T_A = -40^{\circ}C$ to $+85^{\circ}C$.) (Note 4)

PARAMETER	CONDITIONS	MIN	TYP	MAX	UNITS
HIGH-VOLTAGE SCAN DRIVER					
GON1 Input-Voltage Range		12		30	V
GON2 Input-Voltage Range		12		30	V
GOFF Input-Voltage Range		-10		-5	V
GOFF Supply Current	A1–A8 = AGND, no load			125	μA
GON1 Supply Current	A1–A8 = AGND, no load			60	μA
GON2 Supply Current	A1–A8 = AGND, no load			20	μA
Output-Voltage Low (Y1–Y8)	$I_{OUT} = 10mA$			$V_{GOFF} + 1$	V
Output-Voltage High (Y1–Y6)	$I_{OUT} = 10mA$	$V_{GON1} - 1$			V
Output-Voltage High (Y7–Y8)	$I_{OUT} = 10mA$	$V_{GON2} - 1$			V
CONTROL INPUTS					
Logic Input-Voltage Threshold Rising (A1–A8)		1.2		2.0	V
Logic Input-Voltage Threshold Falling (A1–A8)		0.67		1.12	V
Logic Input Bias Current (A1–A8)	$V_{A1-A8} = 18V$			55	μA

Note 1: Inhibits boost switching if SUP exceeds the overvoltage threshold. Switching resumes when SUP drops below the threshold.

Note 2: Boost switching is not enabled until SUP is above undervoltage threshold.

Note 3: Guaranteed by design, not production tested.

Note 4: $-40^{\circ}C$ specifications are guaranteed by design, not production tested.

Internal-Switch Boost Regulator with Integrated High-Voltage Level Shifter and Op Amp

Typical Operating Characteristics

(Circuit of Figure 1, $V_{IN} = 3V$, $V_{MAIN} = 8.5V$, $T_A = +25^\circ C$, unless otherwise noted.)

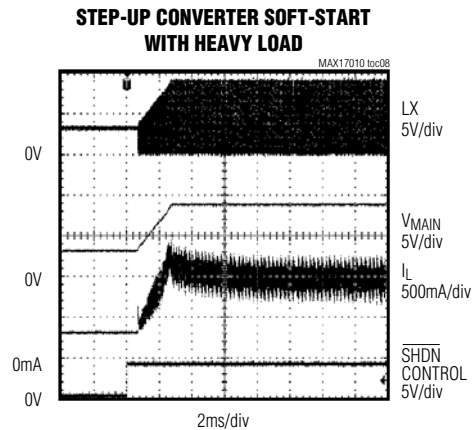
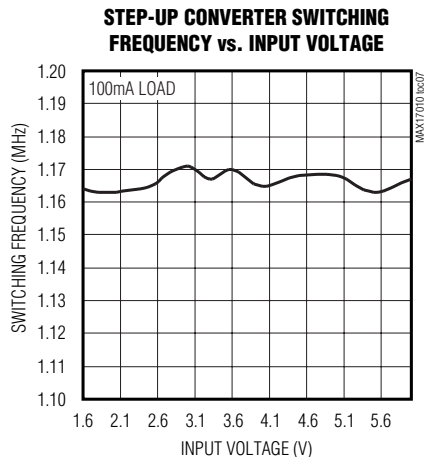
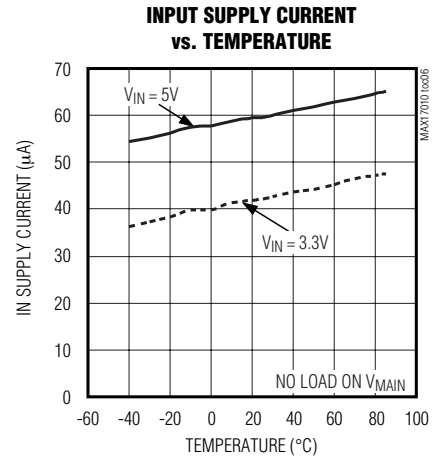
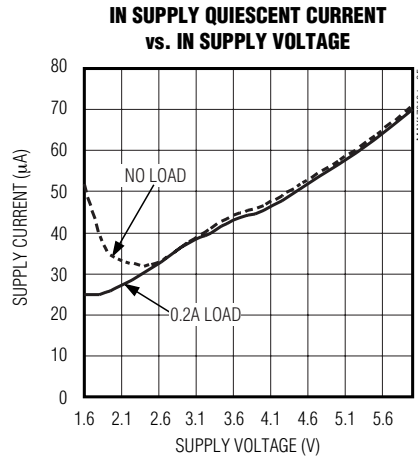
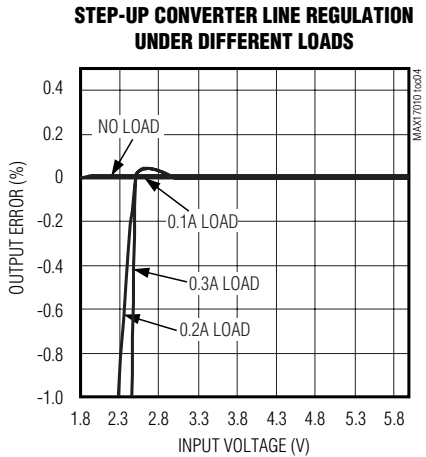
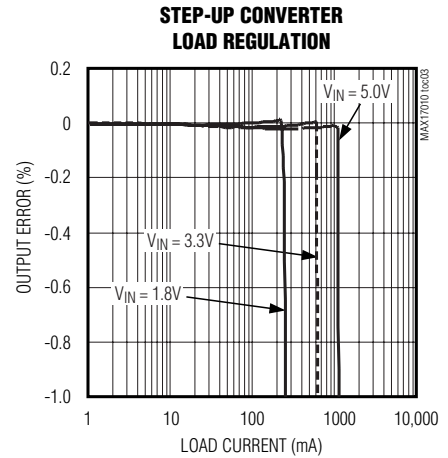
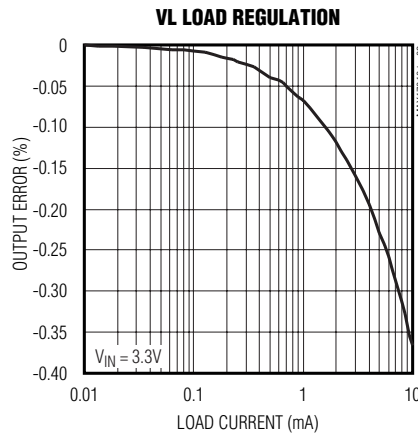
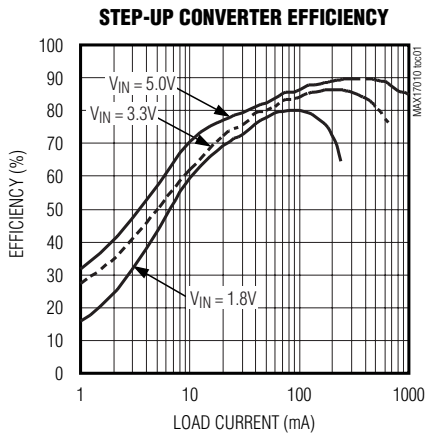

Internal-Switch Boost Regulator with Integrated High-Voltage Level Shifter and Op Amp

Typical Operating Characteristics (continued)

(Circuit of Figure 1, $V_{IN} = 3V$, $V_{MAIN} = 8.5V$, $T_A = +25^\circ C$, unless otherwise noted.)

STEP-UP CONVERTER LOAD-TRANSIENT RESPONSE (30mA TO 300mA)

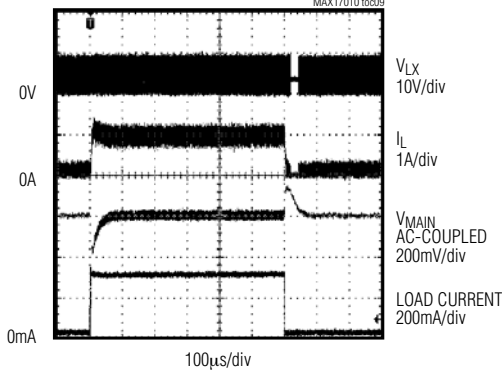

STEP-UP CONVERTER PULSED LOAD-TRANSIENT RESPONSE (30mA TO 1A)

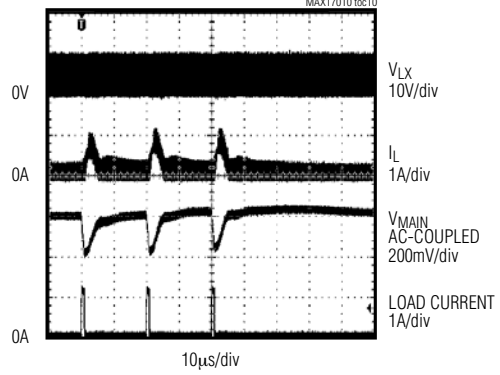

STEP-UP CONVERTER TIMER DELAY LATCH RESPONSE TO OVERLOAD

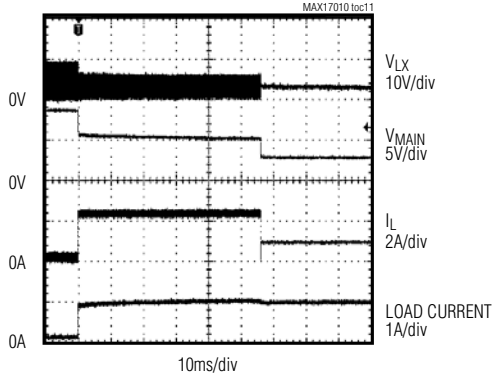

POWER-UP SEQUENCE OF ALL SUPPLY OUTPUTS

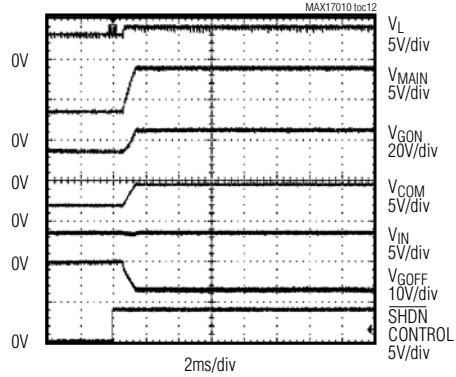

SUP SUPPLY CURRENT vs. TEMPERATURE

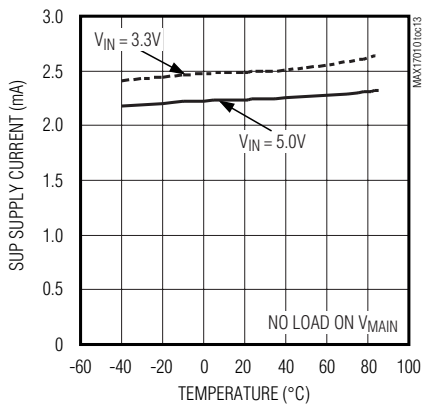

OPERATIONAL AMPLIFIER FREQUENCY RESPONSE

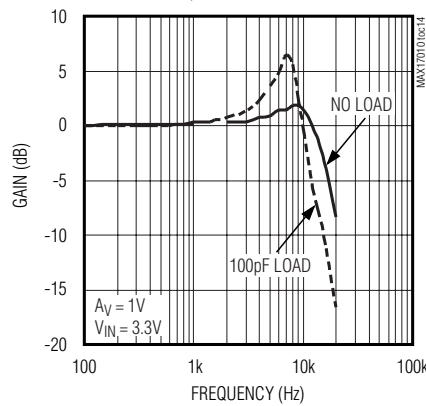

OPERATIONAL AMPLIFIER POWER-SUPPLY REJECTION RATIO

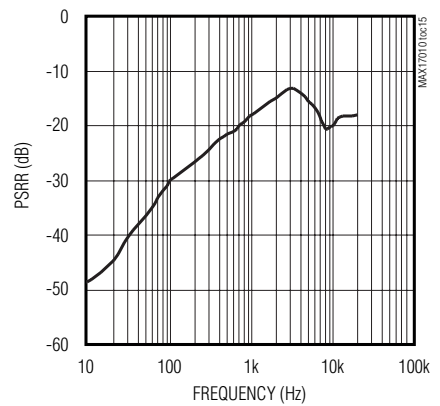

Internal-Switch Boost Regulator with Integrated High-Voltage Level Shifter and Op Amp

Typical Operating Characteristics (continued)

(Circuit of Figure 1, $V_{IN} = 3V$, $V_{MAIN} = 8.5V$, $T_A = +25^\circ C$, unless otherwise noted.)

OPERATIONAL AMPLIFIER RAIL-TO-RAIL INPUT/OUTPUT WAVEFORMS

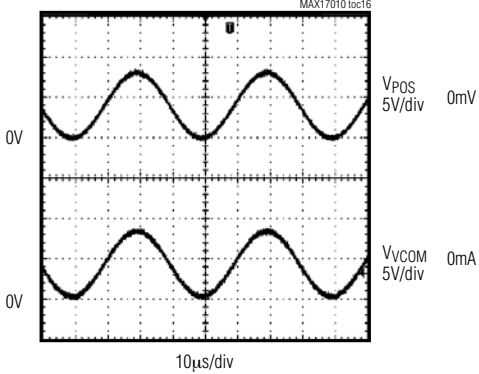

OPERATIONAL AMPLIFIER LOAD-TRANSIENT RESPONSE

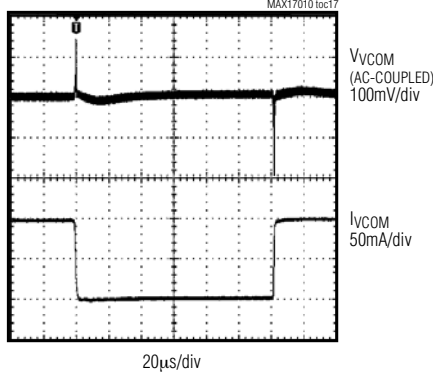

OPERATIONAL AMPLIFIER LARGE-SIGNAL STEP RESPONSE

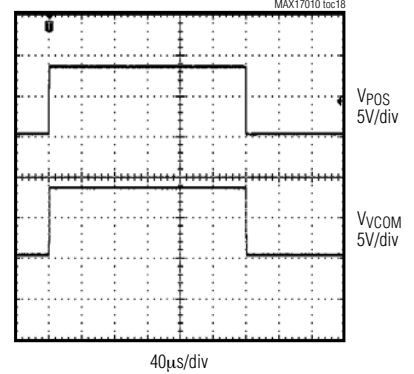

OPERATIONAL AMPLIFIER SMALL-SIGNAL STEP RESPONSE

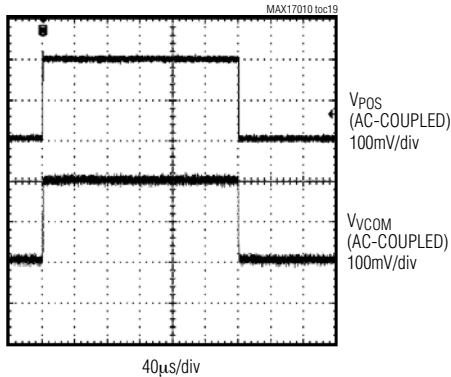

SCAN DRIVER INPUT/OUTPUT WAVEFORMS WITH LOGIC INPUT

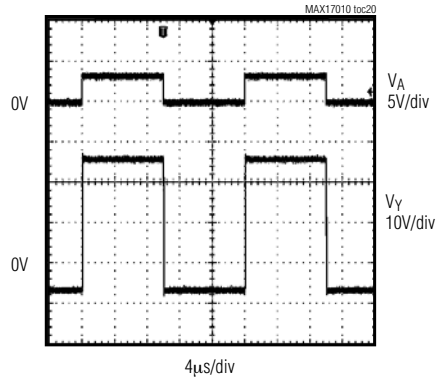

SCAN DRIVER PROPAGATION DELAY (RISING EDGE)

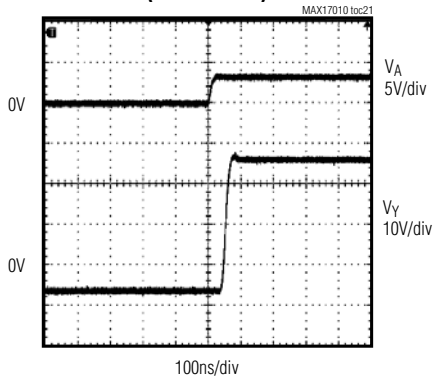

SCAN DRIVER PROPAGATION DELAY (FALLING EDGE)

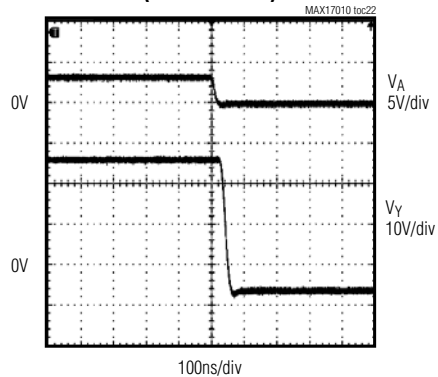

Internal-Switch Boost Regulator with Integrated High-Voltage Level Shifter and Op Amp

Pin Description

MAX17010

PIN	NAME	FUNCTION
1, 24, 30, 31, 40	N.C.	No Connection. Not internally connected.
2, 3	PGND	Power Ground. Source connection of the internal step-up regulator power switch.
4	FB	Feedback Pin. Connect external resistor-divider tap here and minimize trace area. Set V_{OUT} according to: $V_{OUT} = 1.235V (1 + R1/R2)$ (Figure 1).
5	AGND	Ground
6	GON1	Gate-On Supply. GON1 is the positive supply for the Y1–Y6 level-shifter circuitry. Bypass to AGND with a minimum 0.1 μ F ceramic capacitor.
7	GOFF	Gate-Off Supply. GOFF is the negative supply voltage for the Y1–Y8 high-voltage driver outputs. Bypass to AGND with a minimum 0.1 μ F ceramic capacitor.
8–11	A1–A4	High-Voltage-Driver Logic-Level Inputs
12–19	Y1–Y8	Level-Shifter High-Voltage Outputs
20–23	A5–A8	High-Voltage-Driver Logic-Level Inputs
25	GON2	Gate-On Supply. GON2 is the positive supply for the Y7 and Y8 level-shifter circuitry. Bypass to AGND with a minimum 0.1 μ F ceramic capacitor.
26	AGND	Ground. Internally connected to pin 5.
27	COMP	Compensation Pin for Error Amplifier. Connect a series RC from this pin to AGND. Typical values are 100k Ω and 220pF.
28	VL	4V On-Chip Regulator Output. This regulator powers internal analog circuitry for the boost and op amp. Bypass VL to AGND with a 0.22 μ F or greater ceramic capacitor.
29	BGND	Amplifier Ground
32	SUP	Op Amp and Internal VL Linear Regulator Supply Input. Bypass SUP to BGND with a 0.1 μ F capacitor.
33	POS	Op Amp Noninverting Input
34	NEG	Op Amp Inverting Input
35	VCOM	Op Amp Output
36	$\overline{\text{SHDN}}$	Shutdown Control Input. Pull $\overline{\text{SHDN}}$ low to turn off the DC-DC converter and high-voltage drivers only (VL and op amp remain on).
37	IN	Supply Pin. Bypass to AGND with a minimum 0.1 μ F ceramic capacitor.
38, 39	LX	Switching Node. Connect inductor/catch diode here and minimize trace area for lowest EMI.
—	EP	Exposed Backside Paddle

Internal-Switch Boost Regulator with Integrated High-Voltage Level Shifter and Op Amp

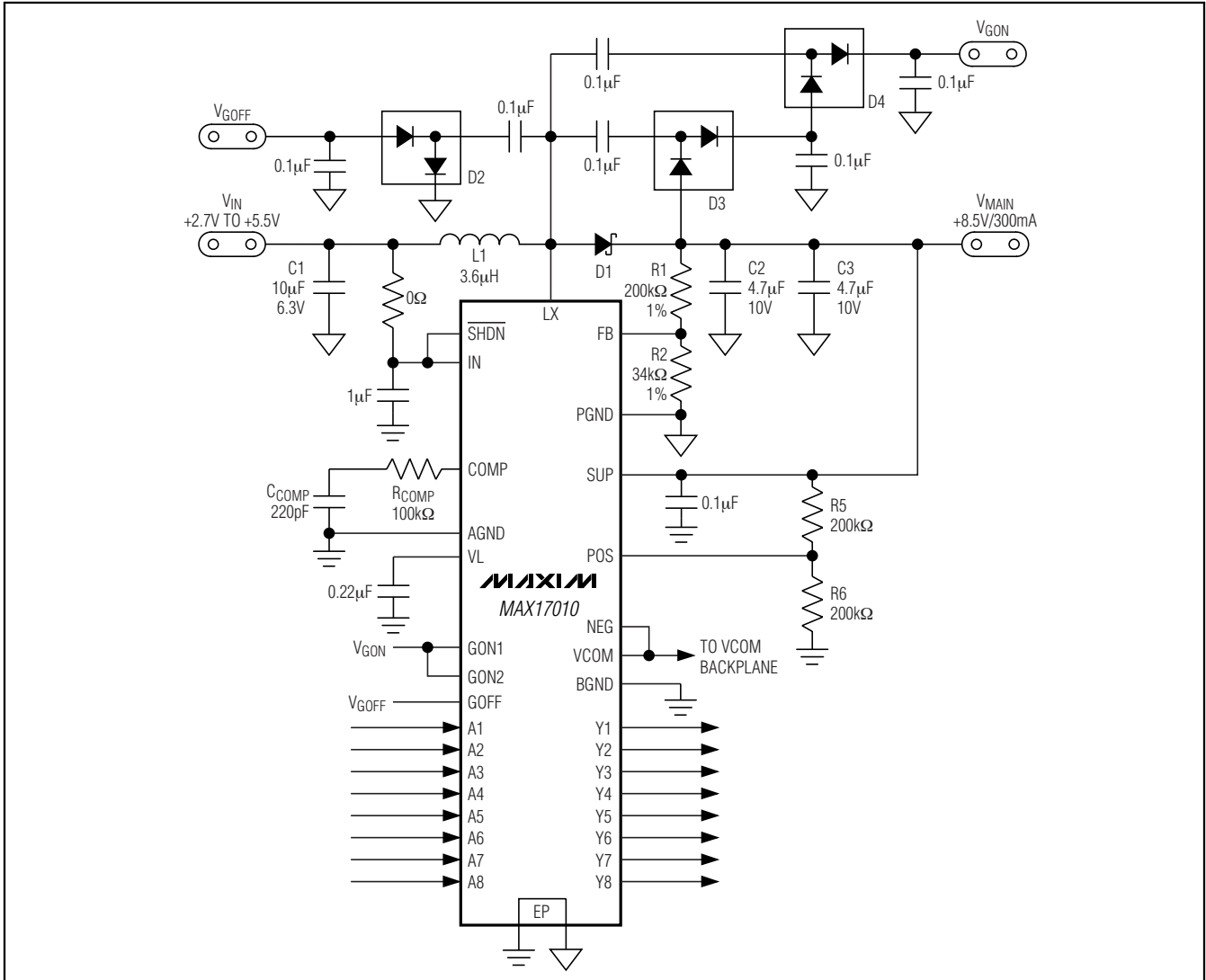

Figure 1. MAX17010 Typical Application Circuit

Typical Application Circuit

The MAX17010 typical application circuit (Figure 1) generates a +8.5V source-driver supply and approximately +22V and -7V gate-driver supplies for TFT displays. The input voltage range for the IC is from +1.8V to +5.5V, but the Figure 1 circuit is designed to run from 2.7V to 5.5V. Table 1 lists the recommended components and Table 2 lists the contact information of component suppliers.

Table 1. Component List

DESIGNATION	DESCRIPTION
C1	10µF, 6.3V X5R ceramic capacitor (1206) TDK C3216X5R0J106M
C2, C3	4.7µF, 10V X5R ceramic capacitors (1206) TDK C3216X5R1A475M
D1	3A, 30V Schottky diode (M-flat) Toshiba CMS02
D2, D3, D4	200mA, 100V, dual, ultra-fast diodes (SOT23) Fairchild MMBD4148SE
L1	3.6µH, 1.8A inductor Sumida CMD6D11BHPNP-3R6MC

Internal-Switch Boost Regulator with Integrated High-Voltage Level Shifter and Op Amp

Table 2. Component Suppliers

SUPPLIER	PHONE	FAX	WEBSITE
Fairchild	408-822-2000	408-822-2102	www.fairchildsemi.com
Sumida	847-545-6700	847-545-6720	www.sumida.com
TDK	847-803-6100	847-390-4405	www.component.tdk.com
Toshiba	949-455-2000	949-859-3963	www.toshiba.com/taec

Note: Indicate that you are using the MAX17010 when contacting these component suppliers.

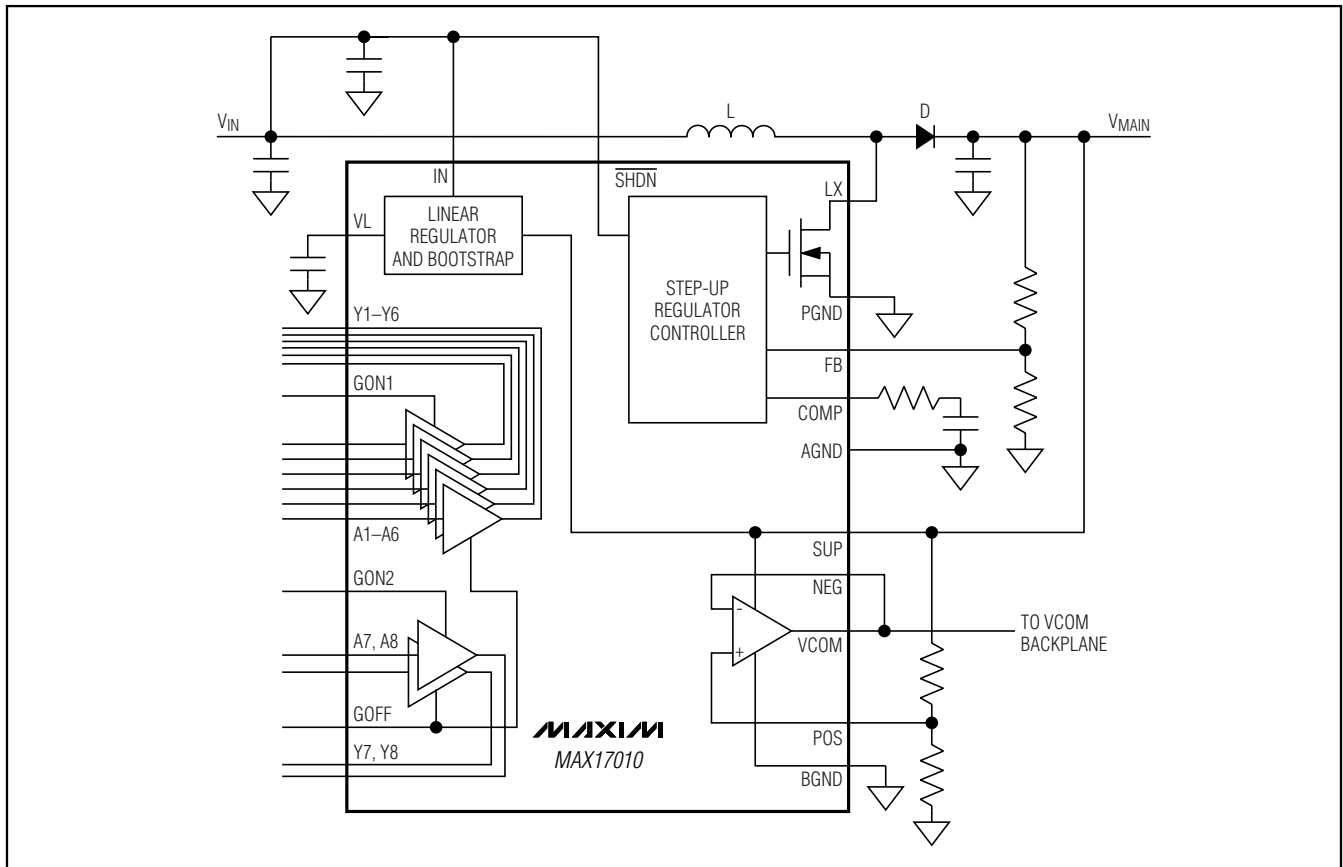

Figure 2. MAX17010 Functional Diagram

Detailed Description

The MAX17010 contains a high-performance step-up switching regulator, a high-speed op amp, and a high-voltage, level-shifting scan driver optimized for active-matrix TFT LCDs. Figure 2 shows the MAX17010 functional diagram.

Step-Up Regulator

The step-up regulator employs a current-mode, fixed-frequency PWM architecture to maximize loop bandwidth

and provide fast transient response to pulsed loads found in source drivers of TFT LCD panels. The high switching frequency (1.2MHz) allows the use of low-profile inductors and ceramic capacitors to minimize the thickness of LCD panel designs. The integrated high-efficiency MOSFET and the IC's built-in digital soft-start functions reduce the number of external components required while controlling inrush current. The output voltage can be set from 5V to 18V with an external resistive voltage-divider.

Internal-Switch Boost Regulator with Integrated High-Voltage Level Shifter and Op Amp

The regulator controls the output voltage, and the power delivered to the output, by modulating the duty cycle (D) of the internal power MOSFET in each switching cycle. The duty cycle of the MOSFET is approximated by:

$$D \approx \frac{V_{\text{MAIN}} - V_{\text{IN}}}{V_{\text{MAIN}}}$$

Figure 3 shows the block diagram of the step-up regulator. An error amplifier compares the signal at FB to 1.235V and changes the COMP output. The voltage at COMP determines the current trip point each time the internal MOSFET turns on. As the load varies, the error amplifier sources or sinks current to the COMP output accordingly, to produce the inductor peak current necessary to service the load. To maintain stability at high duty cycles, a slope-compensation signal is summed with the current-sense signal.

On the rising edge of the internal clock, the controller sets a flip-flop, turning on the n-channel MOSFET, and applying the input voltage across the inductor. The current through the inductor ramps up linearly, storing energy in its magnetic field. Once the sum of the current-feedback signal and the slope compensation

exceeds the COMP voltage, the controller resets the flip-flop and turns off the MOSFET. Since the inductor current is continuous, a transverse potential develops across the inductor that turns on the diode (D1). The voltage across the inductor then becomes the difference between the output voltage and the input voltage. This discharge condition forces the current through the inductor to ramp back down, transferring the energy stored in the magnetic field to the output capacitor and the load. The MOSFET remains off for the rest of the clock cycle.

Undervoltage Lockout (UVLO)

The undervoltage lockout (UVLO) circuit compares the input voltage at IN with the UVLO threshold (1.3V rising and 1.2V falling) to ensure that the input voltage is high enough for reliable operation. The 100mV (typ) hysteresis prevents supply transients from causing a restart. Once the input voltage exceeds the UVLO rising threshold, startup begins. When the input voltage falls below the UVLO falling threshold, the controller turns off the main step-up regulator and the linear regulator outputs, disables the switch-control block, and the op amp outputs are high impedance.

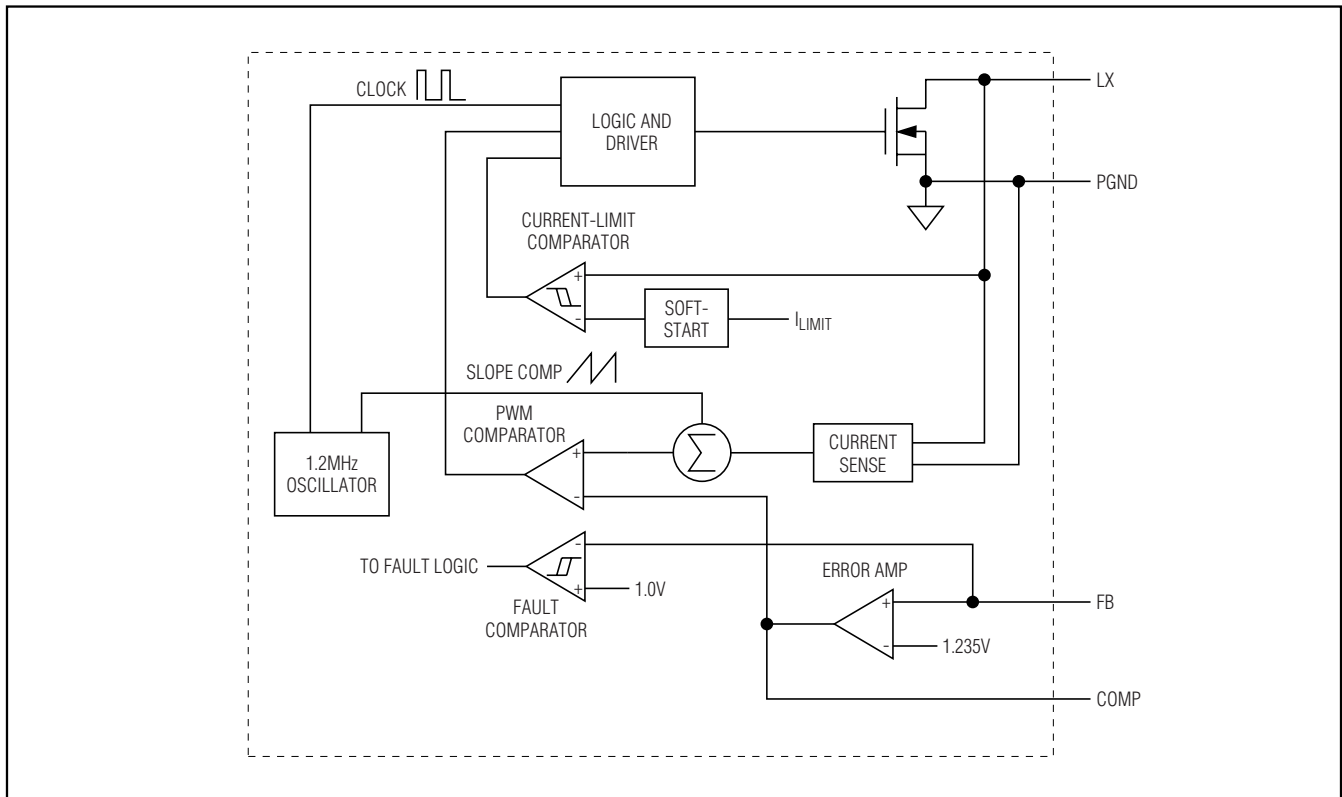

Figure 3. Step-Up Regulator Block Diagram

Internal-Switch Boost Regulator with Integrated High-Voltage Level Shifter and Op Amp

Linear Regulator (VL)

The MAX17010 includes an internal 4V linear regulator. SUP is the input of the linear regulator. The input voltage range is between 5V and 18V. The output of the linear regulator (VL) is set to 4V (typ). The regulator powers all the internal circuitry including the MOSFET gate driver. Bypass the VL pin to AGND with a 0.22 μ F or greater ceramic capacitor. SUP should be directly connected to the output of the step-up regulator. This feature significantly improves the efficiency at low input voltages.

Bootstrapping and Soft-Start

The MAX17010 features bootstrapping operation. In normal operation, the internal linear regulator supplies power to the internal circuitry. The input of the linear regulator (SUP) should be directly connected to the output of the step-up regulator. The MAX17010 is enabled when the input voltage at SUP is above 1.4V and the fault latch is not set. After being enabled, the regulator starts open-loop switching to generate the supply voltage for the linear regulator. Step-up switching is inhibited if the step-up output voltage (VMAIN) exceeds the voltage on the SUP input. The internal reference block turns on when the VL voltage exceeds 2.7V (typ). When the reference voltage reaches regulation, the PWM controller and the current-limit circuit are enabled and the step-up regulator enters soft-start. During soft-start, the main step-up regulator directly limits the peak inductor current, allowing from zero up to the full current-limit value in 128 equal current steps. The maximum load current is available after the output voltage reaches regulation (which terminates soft-start), or after the soft-start timer expires in approximately 3ms. The soft-start routine minimizes the inrush current and voltage overshoot, and ensures a well-defined startup behavior.

Fault Protection

During steady-state operation, the MAX17010 monitors the FB voltage. If the FB voltage does not exceed 1V (typ), the MAX17010 activates an internal fault timer. If there is a continuous fault for the fault-timer duration, the MAX17010 sets the fault latch, shutting down all the outputs except VL. Once the fault condition is removed, cycle the input voltage to clear the fault latch and reactivate the device. The fault-detection circuit is disabled during the soft-start time.

The MAX17010 monitors the SUP voltage for undervoltage and overvoltage conditions. If the SUP voltage is below 1.4V (typ) or above 19V (typ), the MAX17010 disables the gate driver of the step-up regulator and prevents the internal MOSFET from switching. The SUP undervoltage and overvoltage conditions do not set the fault latch.

Op Amps

The MAX17010 has an op amp that is typically used to drive the LCD backplane (VCOM) and/or the gamma-correction-divider string. The op amp features ± 150 mA output short-circuit current, 45V/ μ s slew rate, and 12MHz bandwidth. While the op amp is a rail-to-rail input and output design, its accuracy is significantly degraded for input voltages within 1V of its supply rails (SUP and VGND).

Short-Circuit Current Limit

The op amp limits short-circuit current to approximately ± 150 mA if the output is directly shorted to SUP or to AGND. If the short-circuit condition persists, the junction temperature of the IC rises until it reaches the thermal-shutdown threshold (+160°C typ). Once the junction temperature reaches the thermal-shutdown threshold, an internal thermal sensor immediately sets the thermal fault latch, shutting off all the IC's outputs except VL. The device remains inactive until the input voltage is cycled.

Driving Pure Capacitive Load

The op amp is typically used to drive the LCD backplane (VCOM) or the gamma-correction-divider string. The LCD backplane consists of a distributed series capacitance and resistance, a load that can be easily driven by the op amp. However, if the op amp is used in an application with a pure capacitive load, steps must be taken to ensure stable operation.

As the op amp's capacitive load increases, the amplifier's bandwidth decreases and the gain peaking increases. A 5 Ω to 50 Ω small resistor placed between VCOM and the capacitive load reduces peaking but also reduces the gain. An alternative method of reducing peaking is to place a series RC network (snubber) in parallel with the capacitive load. The RC network does not continuously load the output or reduce the gain.

High-Voltage Level-Shifting Scan Driver

The MAX17010 includes eight logic-level to high-voltage level-shifting buffers, which can buffer eight logic inputs (A1–A8) and shift them to a desired level (Y1–Y8) to drive TFT-LCD row logic. The driver outputs, Y1–Y8, swing between their power-supply rails, according to the input-logic level on A1–A8. The driver output is GOFF when its respective input is logic low, and GON₁ when its respective input is logic high. These eight driver channels are grouped for different high-level supplies. A1–A6 are supplied from GON1, and A7 and A8 are supplied from GON2. GON1 and GON2 can be tied together to make A1–A8 use identical supplies.

Internal-Switch Boost Regulator with Integrated High-Voltage Level Shifter and Op Amp

The high-voltage, level-shifting scan drivers are designed to drive the TFT panels with row-drivers integrated on the panel glass. Its eight outputs swing from +30V (max) to -6.3V (min) and can swiftly drive capacitive loads. The typical propagation delays are 40ns, with fast 16ns rise-and-fall times. The buffers can operate at frequencies up to 50kHz.

Thermal-Overload Protection

The thermal-overload protection prevents excessive power dissipation from overheating the device. When the junction temperature exceeds $T_J = +160^\circ\text{C}$, a thermal sensor immediately activates the fault protection, which shuts down all outputs except VL, allowing the device to cool down. Once the device cools down by approximately 15°C , cycle the input voltage (below the UVLO-falling threshold) to clear the fault latch and reactivate the device.

The thermal-overload protection protects the controller in the event of fault conditions. For continuous operation, do not exceed the absolute maximum junction temperature rating of $T_J = +150^\circ\text{C}$.

Design Procedure

Main Step-Up Regulator

Inductor Selection

The minimum inductance value, peak current rating, and series resistance are factors to consider when selecting the inductor. These factors influence the converter's efficiency, maximum output-load capability, transient response time, and output-voltage ripple. Physical size and cost are also important factors to be considered.

The maximum output current, input voltage, output voltage, and switching frequency determine the inductor value. Very high inductance values minimize the current ripple and therefore reduce the peak current, which decreases core losses in the inductor and I^2R losses in the entire power path. However, large inductor values also require more energy storage and more turns of wire, which increase physical size and can increase I^2R losses in the inductor. Low inductance values decrease the physical size but increase the current ripple and peak current. Finding the best inductor involves choosing the best compromise between circuit efficiency, inductor size, and cost.

The equations used here include a constant (LIR), which is the ratio of the inductor peak-to-peak ripple current to the average DC inductor current at the full-load current. The best trade-off between inductor size and circuit efficiency for step-up regulators generally has an LIR between 0.3 and 0.5. However, depending on the AC characteristics of the inductor core material

and ratio of inductor resistance to other power-path resistances, the best LIR can shift up or down. If the inductor resistance is relatively high, more ripple can be accepted to reduce the number of turns required and increase the wire diameter. If the inductor resistance is relatively low, increasing inductance to lower the peak current can decrease losses throughout the power path. If extremely thin high-resistance inductors are used, as is common for LCD panel applications, the best LIR can increase to between 0.5 and 1.0.

Once a physical inductor is chosen, higher and lower values of the inductor should be evaluated for efficiency improvements in typical operating regions.

Calculate the approximate inductor value using the typical input voltage (V_{IN}), the maximum output current ($I_{MAIN(MAX)}$), the expected efficiency (η_{TYP}) taken from an appropriate curve in the *Typical Operating Characteristics*, and an estimate of LIR based on the above discussion:

$$L = \left(\frac{V_{IN}}{V_{MAIN}} \right)^2 \left(\frac{V_{MAIN} - V_{IN}}{I_{MAIN(MAX)} \times f_{OSC}} \right) \left(\frac{\eta_{TYP}}{LIR} \right)$$

Choose an available inductor value from an appropriate inductor family. Calculate the maximum DC input current at the minimum input voltage $V_{IN(MIN)}$ using conservation of energy and the expected efficiency at that operating point (η_{MIN}) taken from an appropriate curve in the *Typical Operating Characteristics*:

$$I_{IN(DC,MAX)} = \frac{I_{MAIN(MAX)} \times V_{MAIN}}{V_{IN(MIN)} \times \eta_{MIN}}$$

Calculate the ripple current at that operating point and the peak current required for the inductor:

$$I_{RIPPLE} = \frac{V_{IN(MIN)} \times (V_{MAIN} - V_{IN(MIN)})}{L \times V_{MAIN} \times f_{OSC}}$$

$$I_{PEAK} = I_{IN(DC,MAX)} + \frac{I_{RIPPLE}}{2}$$

The inductor's saturation current rating and the MAX17010's LX current limit (I_{LIM}) should exceed I_{PEAK} and the inductor's DC current rating should exceed $I_{IN(DC,MAX)}$. For good efficiency, choose an inductor with less than 0.1Ω series resistance.

Considering the *Typical Operating Circuit*, the maximum load current ($I_{MAIN(MAX)}$) is 300mA, with an 8.5V output and a typical input voltage of 3V. Choosing an LIR of 0.45 and estimating efficiency of 85% at this operating point:

$$L = \left(\frac{3V}{8.5V} \right)^2 \left(\frac{8.5V - 3V}{0.3A \times 1.2MHz} \right) \left(\frac{0.85}{0.5} \right) \approx 3.6\mu\text{H}$$

Internal-Switch Boost Regulator with Integrated High-Voltage Level Shifter and Op Amp

Using the circuit's minimum input voltage (2.2V) and estimating efficiency of 80% at that operating point:

$$I_{IN(DC,MAX)} = \frac{0.3A \times 8.5V}{2.2V \times 0.8} \approx 1.45A$$

The ripple current and the peak current are:

$$I_{RIPPLE} = \frac{2.2V \times (8.5V - 2.2V)}{3.6\mu H \times 8.5V \times 1.2MHz} \approx 0.38A$$

$$I_{PEAK} = 1.45A + \frac{0.38A}{2} \approx 1.64A$$

Output Capacitor Selection

The total output-voltage ripple has two components: the capacitive ripple caused by the charging and discharging of the output capacitance, and the ohmic ripple due to the capacitor's equivalent series resistance (ESR):

$$V_{RIPPLE} = V_{RIPPLE(C)} + V_{RIPPLE(ESR)}$$

$$V_{RIPPLE(C)} \approx \frac{I_{MAIN}}{C_{OUT}} \left(\frac{V_{MAIN} - V_{IN}}{V_{MAIN} f_{OSC}} \right)$$

and:

$$V_{RIPPLE(ESR)} \approx I_{PEAK} R_{ESR}(C_{OUT})$$

where I_{PEAK} is the peak inductor current (see the *Inductor Selection* section). For ceramic capacitors, the output-voltage ripple is typically dominated by $V_{RIPPLE(C)}$. The voltage rating and temperature characteristics of the output capacitor must also be considered.

Input Capacitor Selection

The input capacitor (C_{IN}) reduces the current peaks drawn from the input supply and reduces noise injection into the IC. A 10 μ F ceramic capacitor is used in the *Typical Applications Circuit* (Figure 1) because of the high source impedance seen in typical lab setups. Actual applications usually have much lower source impedance since the step-up regulator often runs directly from the output of another regulated supply. Typically, C_{IN} can be reduced below the values used in the *Typical Applications Circuit*. Ensure a low-noise supply at I_{IN} by using adequate C_{IN} . Alternatively, greater voltage variation can be tolerated on C_{IN} if I_{IN} is decoupled from C_{IN} using an RC lowpass filter, as shown in Figure 1.

Rectifier Diode

The MAX17010's high switching frequency demands a high-speed rectifier. Schottky diodes are recommended for most applications because of their fast recovery time and low forward voltage. In general, a 2A Schottky diode complements the internal MOSFET well.

Output Voltage Selection

The output voltage of the main step-up regulator is adjusted by connecting a resistive voltage-divider from the output (V_{MAIN}) to AGND with the center tap connected to FB (see Figure 1). Select R2 in the 10k Ω to 50k Ω range. Calculate R1 with the following equation:

$$R1 = R2 \times \left(\frac{V_{MAIN}}{V_{REF}} - 1 \right)$$

where V_{REF} , the step-up regulator's feedback set point, is 1.235V. Place R1 and R2 close to the IC.

Loop Compensation

Choose R_{COMP} to set the high-frequency integrator gain for fast transient response. Choose C_{COMP} to set the integrator zero to maintain loop stability.

For low-ESR output capacitors, use the following equations to obtain stable performance and good transient response:

$$R_{COMP} \approx \frac{1000 \times V_{IN} \times V_{OUT} \times C_{OUT}}{L \times I_{MAIN(MAX)}}$$

$$C_{COMP} \approx \frac{V_{OUT} \times C_{OUT}}{10 \times I_{MAIN(MAX)} \times R_{COMP}}$$

To further optimize transient response, vary R_{COMP} in 20% steps and C_{COMP} in 50% steps, while observing transient response waveforms.

Applications Information

Power Dissipation

An IC's maximum power dissipation depends on the thermal resistance from the die to the ambient environment, and the ambient temperature. The thermal resistance depends on the IC package, PCB copper area, other thermal mass, and airflow.

The MAX17010, with its exposed backside paddle soldered to an internal ground layer in a typical multilayer PCB, can dissipate about 2.8W into +70°C still air. More PCB copper, cooler ambient air, and more airflow increase the possible dissipation, while less copper or warmer air decreases the IC's dissipation capability. The major components of power dissipation are the power dissipated in the step-up regulator and the power dissipated by the op amps.

Internal-Switch Boost Regulator with Integrated High-Voltage Level Shifter and Op Amp

Step-Up Regulator

The largest portions of power dissipation in the step-up regulator are the internal MOSFET, inductor, and the output diode. If the step-up regulator has 90% efficiency, about 3% to 5% of the power is lost in the internal MOSFET, about 3% to 4% in the inductor, and about 1% in the output diode. The remaining 1% to 3% is distributed among the input and output capacitors and the PCB traces. If the input power is about 5W, the power lost in the internal MOSFET is about 150mW to 250mW.

Op Amp

The power dissipated in the op amp depends on its output current, the output voltage, and the supply voltage:

$$P_{DSOURCE} = I_{VCOM(SOURCE)} \times (V_{SUP} - V_{VOUT})$$

$$P_{DSINK} = I_{VCOM(SINK)} \times V_{VOUT}$$

where $I_{VCOM(SOURCE)}$ is the output current sourced by the op amp, and $I_{VCOM(SINK)}$ is the output current that the op amp sinks.

In a typical case where the supply voltage is 8.5V, and the output voltage is 4V with an output source current of 30mA, the power dissipated is 135mW.

PCB Layout and Grounding

Careful PCB layout is important for proper operation. Use the following guidelines for good PCB layout:

- 1) Minimize the area of high-current loops by placing the inductor, output diode, and output capacitors near the input capacitors and near the LX and PGND pins. The high-current input loop goes from the positive terminal of the input capacitor to the inductor, to the IC's LX pins, out of PGND, and to the input capacitor's negative terminal. The high-current output loop is from the positive terminal of the input capacitor to the inductor, to the output diode (D1), to the positive terminal of the output capacitors, reconnecting between the output-capacitor and input-capacitor ground terminals. Connect these loop components with short, wide connections. Avoid using vias in the high-current paths. If vias are unavoidable, use many vias in parallel to reduce resistance and inductance.
- 2) Create a power ground island (PGND) consisting of the input- and output-capacitor grounds, PGND pin, and any charge-pump components. Connect all these together with short, wide traces or a small ground plane. Maximizing the width of the power-ground traces improves efficiency and reduces output-voltage ripple and noise spikes. Create an analog ground plane (AGND) consisting of the AGND pin, all the feedback-divider ground connections, the op-amp-divider ground connections, the COMP capacitor ground connection, the SUP and VL bypass-capacitor ground connections, and the device's exposed backside pad. Connect the AGND and PGND islands by connecting the PGND pin directly to the exposed backside pad. Make no other connections between these separate ground planes.
- 3) Place the feedback-voltage-divider resistors as close to the feedback pin as possible. The divider's center trace should be kept short. Placing the resistors far away causes the FB trace to become an antenna that can pick up switching noise. Care should be taken to avoid running the feedback trace near LX or the switching nodes in the charge pumps.
- 4) Place the IN pin and VL pin bypass capacitors as close to the device as possible. The ground connections of the IN and VL bypass capacitors should be connected directly to the AGND pin or the IC's backside pad with a wide trace.
- 5) Minimize the length and maximize the width of the traces between the output capacitors and the load for best transient responses.
- 6) Minimize the size of the LX node while keeping it wide and short. Keep the LX node away from the feedback node and analog ground. Use DC traces as shield if necessary.
- 7) Refer to the MAX17010 evaluation kit for an example of proper board layout.

Internal-Switch Boost Regulator with Integrated High-Voltage Level Shifter and Op Amp

MAX17010

Pin Configuration

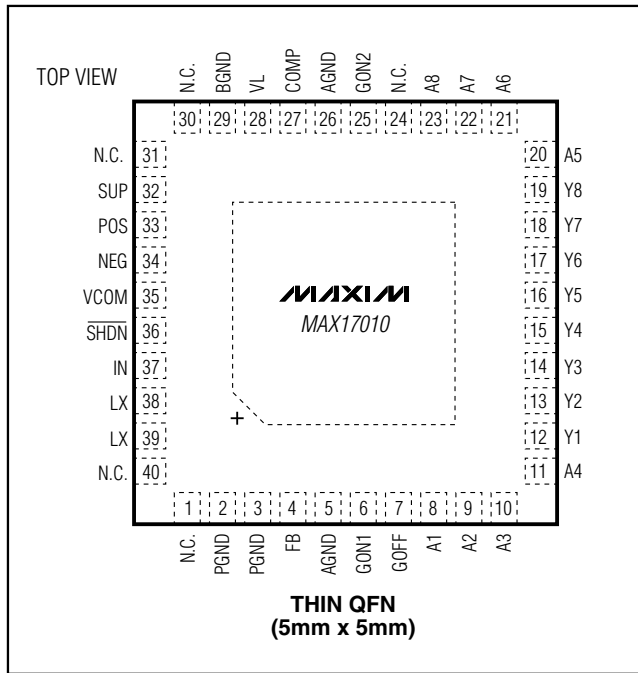

Chip Information

TRANSISTOR COUNT: 9202

PROCESS: BiCMOS

Package Information

For the latest package outline information, go to www.maxim-ic.com/packages.

Maxim cannot assume responsibility for use of any circuitry other than circuitry entirely embodied in a Maxim product. No circuit patent licenses are implied. Maxim reserves the right to change the circuitry and specifications without notice at any time.

Maxim Integrated Products, 120 San Gabriel Drive, Sunnyvale, CA 94086 408-737-7600 _____ 17